



**ENGLISH**  
*time*

APOSTILA  
**CONVERSAÇÃO I**



# SCHOOL

## SIXTEENTH CLASS:

**1 - ORGANIZE THE OBJECTS AND WRITE IN THE TABLE.**

**(ORGANIZE OS OBJETOS E ESCREVA NA TABELA)**



**3**



**4**



**2**

<b>1</b>
<b>2</b>
<b>3</b>
<b>4</b>
<b>5</b>



**1**



**5**

**CALENDAR**

**WASTE BASKET**

**CLOCK**

**GLOBE**

**BROOM**



8



7



10



6



7



8



9



10



6



9

**SMART BOARD**

**CHAIR**

**WHITE BOARD**

**DESK**

**BOOKS**



## 2 - COMPLETE THE WORDS AND WRITE THEM.

(COMPLETE AS PALAVRAS E ENCONTRE-AS NO DIAGRAMA)



P\_\_\_\_\_



R\_\_\_\_\_



D\_\_\_\_\_



P\_\_\_\_\_C\_\_\_\_\_



N\_\_\_\_\_



P\_\_\_\_

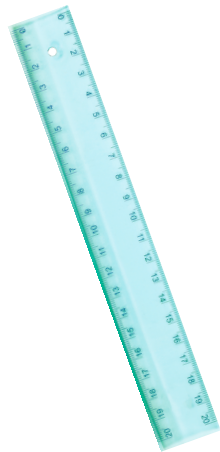

R\_\_\_\_\_



B\_\_\_\_



B\_\_\_\_\_





### 3 - WRITE THE CORRECT NUMBER IN FRONT OF EACH WORD:

(ESCREVA O NÚMERO CORRETO NA FRENTE DE CADA PALAVRA)

- SCHOOLBAG
- SHARPENER
- ERASER
- SCISSORS
- NOTEBOOK
- PENCIL CASE

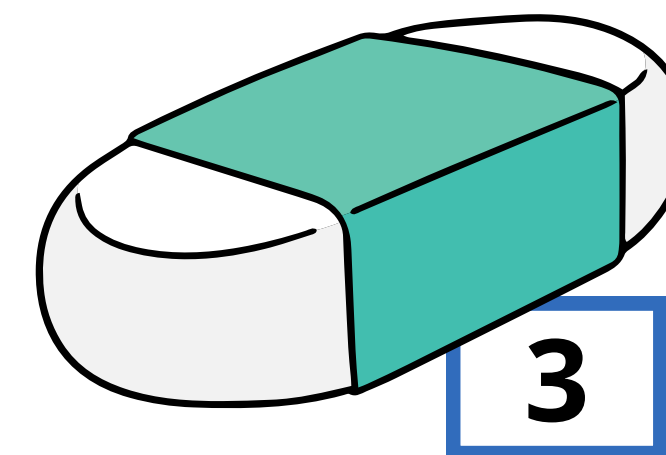
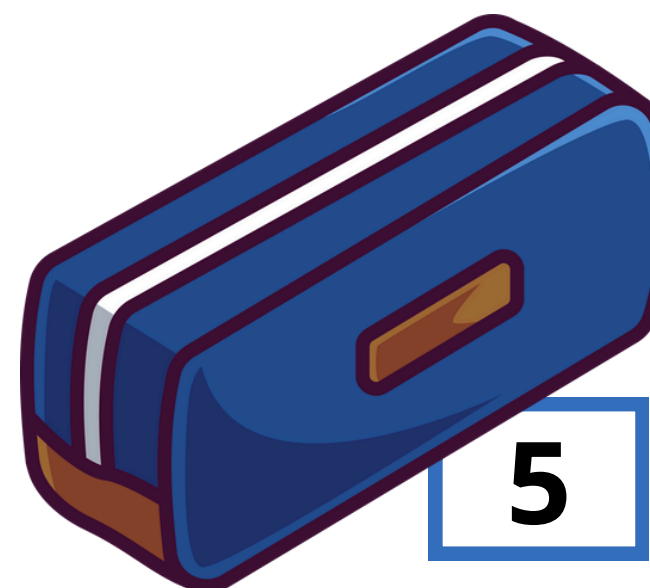
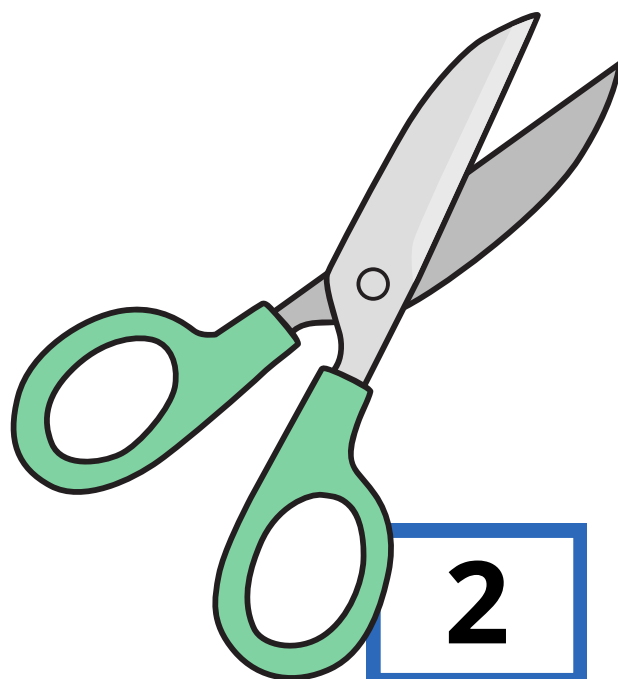
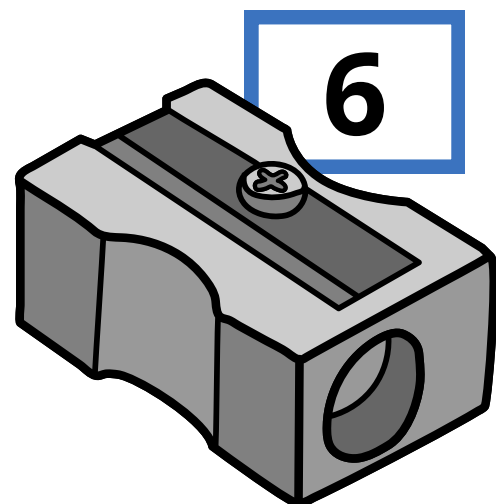



### 3 - WRITE THE CORRECT NUMBER IN FRONT OF EACH WORD:

(ESCREVA O NÚMERO CORRETO NA FRENTE DE CADA PALAVRA)

PENCIL	<input type="text"/>
RULER	<input type="text"/>
GLOBE	<input type="text"/>
COMPUTER	<input type="text"/>
PEN	<input type="text"/>
CALCULATOR	<input type="text"/>

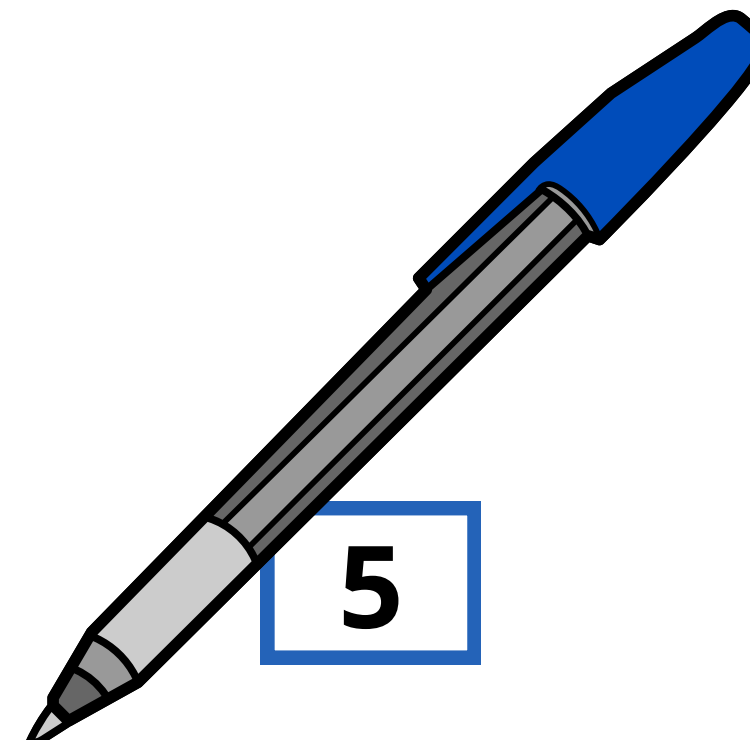
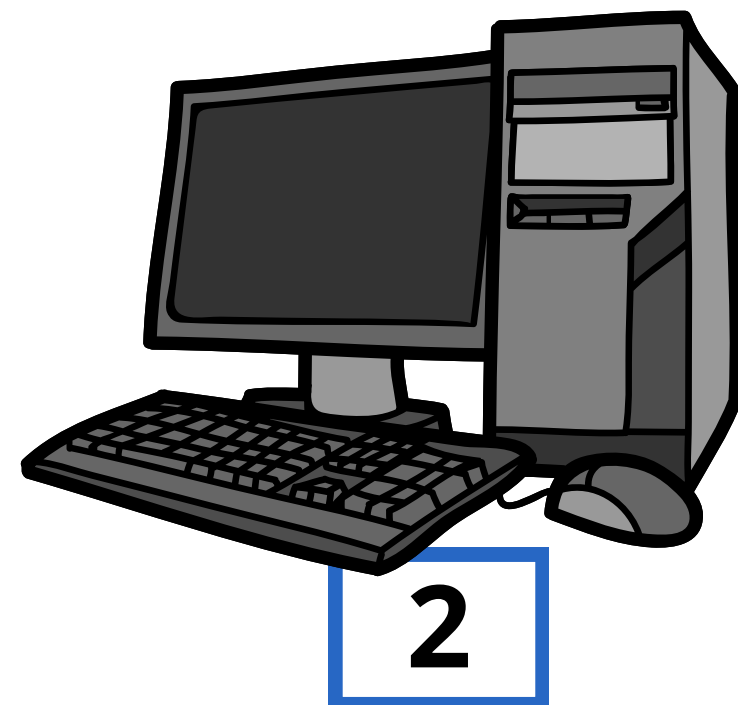
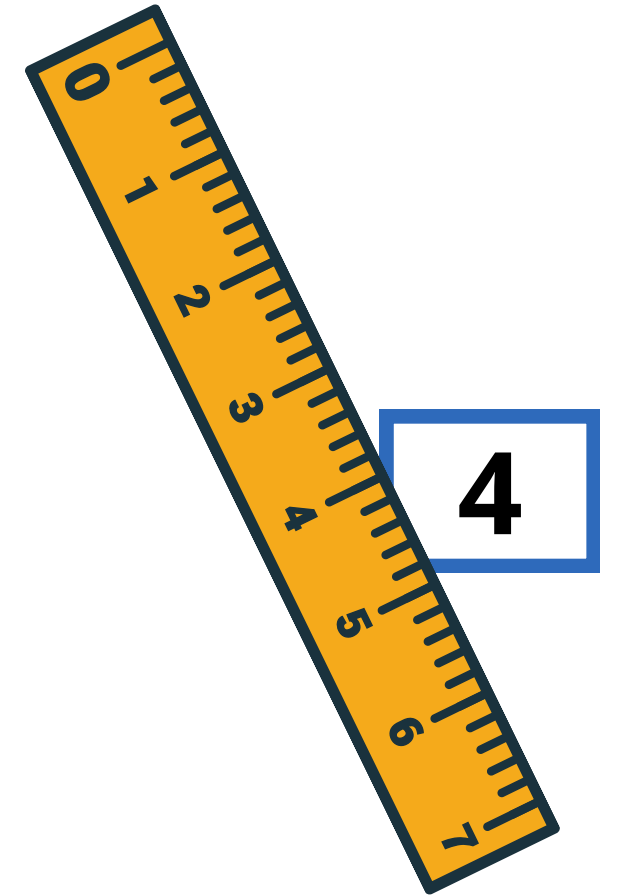



**4 - CHOOSE THE CORRECT OPTION.**  
(ESCOLHA A OPÇÃO CORRETA)

**RULER**

**RUBBER**

**PEN**

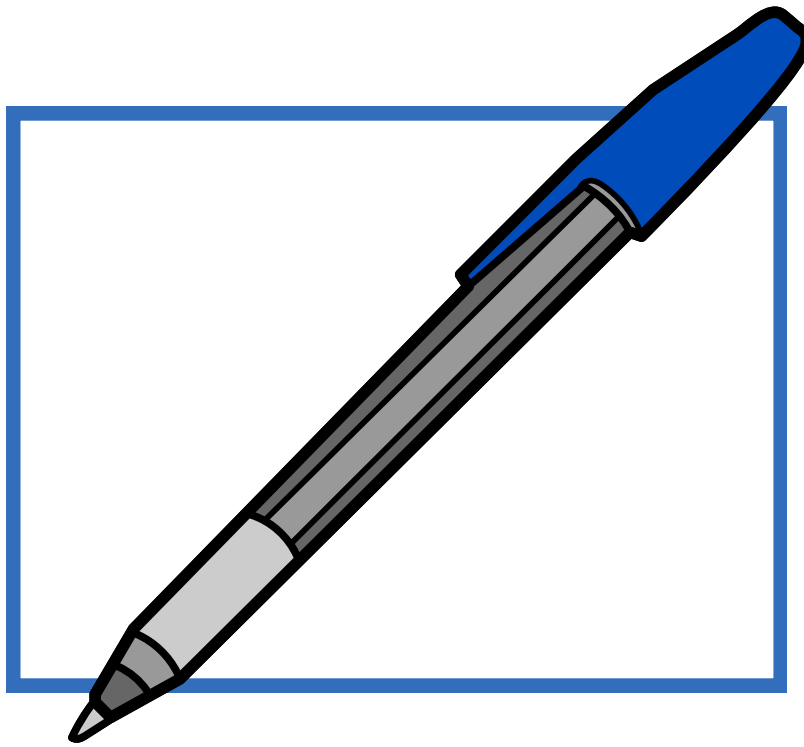

**BOOK**

**RUBBER**

**PEN**

**SCISSORS**

**GLUE**

**PENCIL**

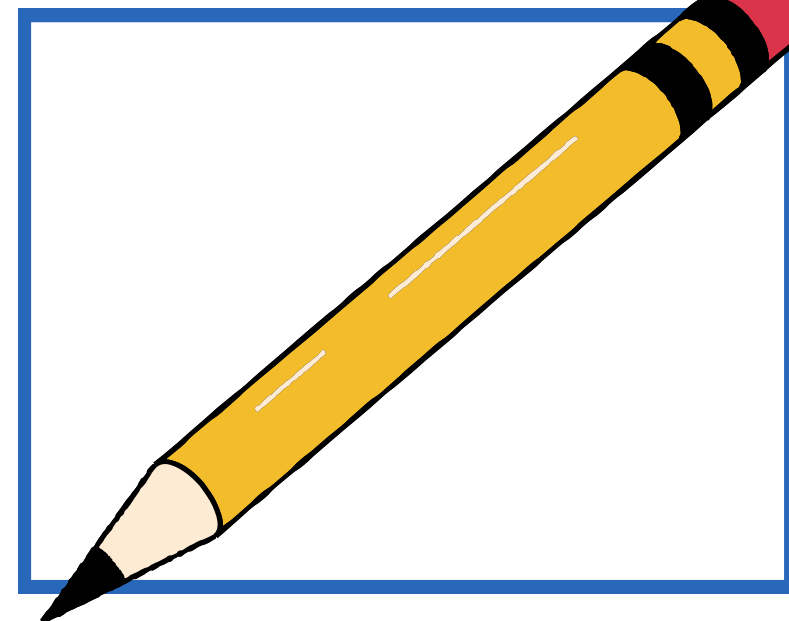
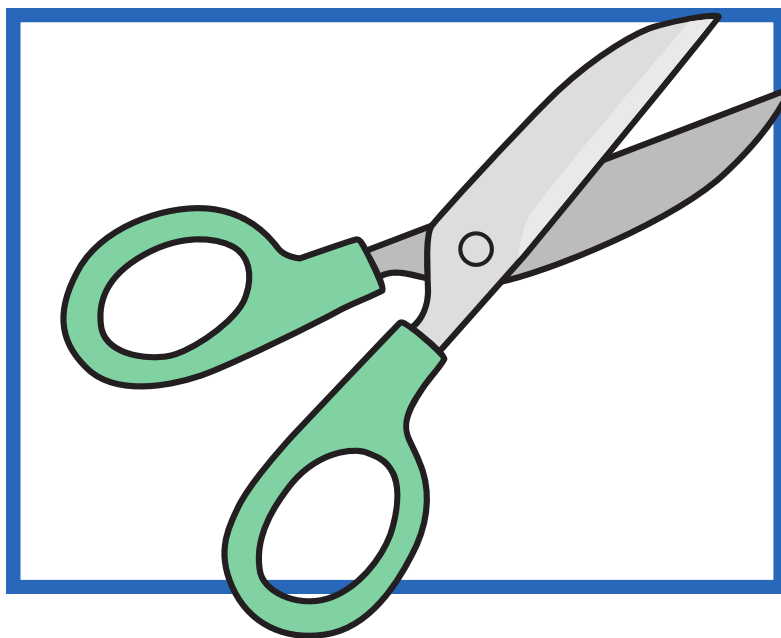

**PENCIL**

**PEN**

**BOOK**



**4 - CHOOSE THE CORRECT OPTION.**  
(ESCOLHA A OPÇÃO CORRETA)

**RULER**

**RUBBER**

**PEN**

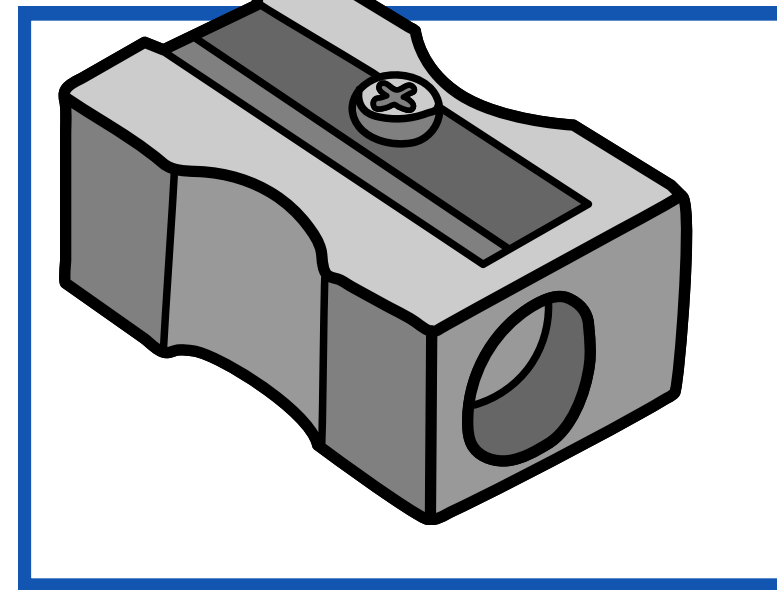
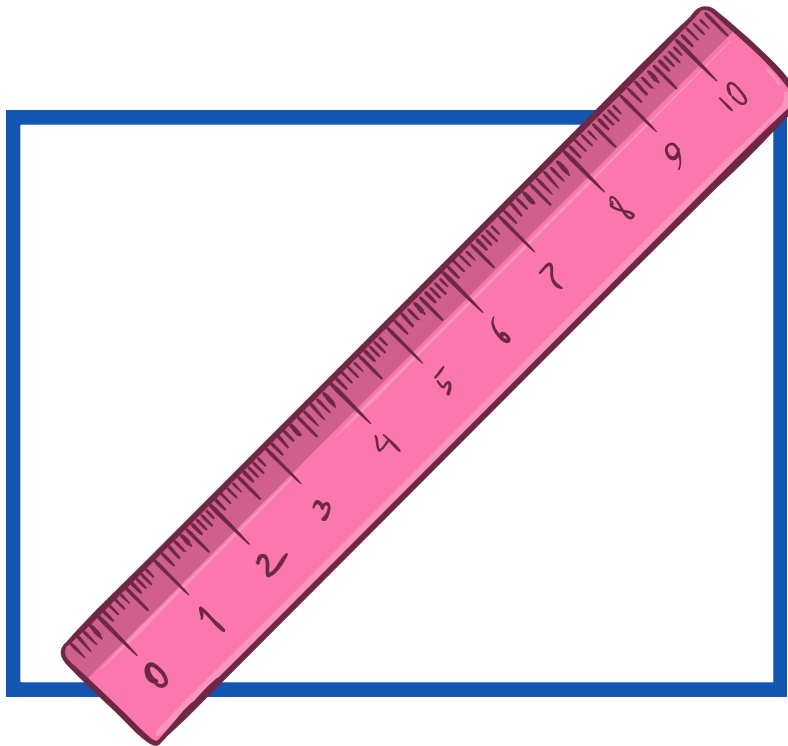

**BOOK**

**SHARPENER**

**PEN**

**SCISSORS**

**GLUE**

**PENCIL**

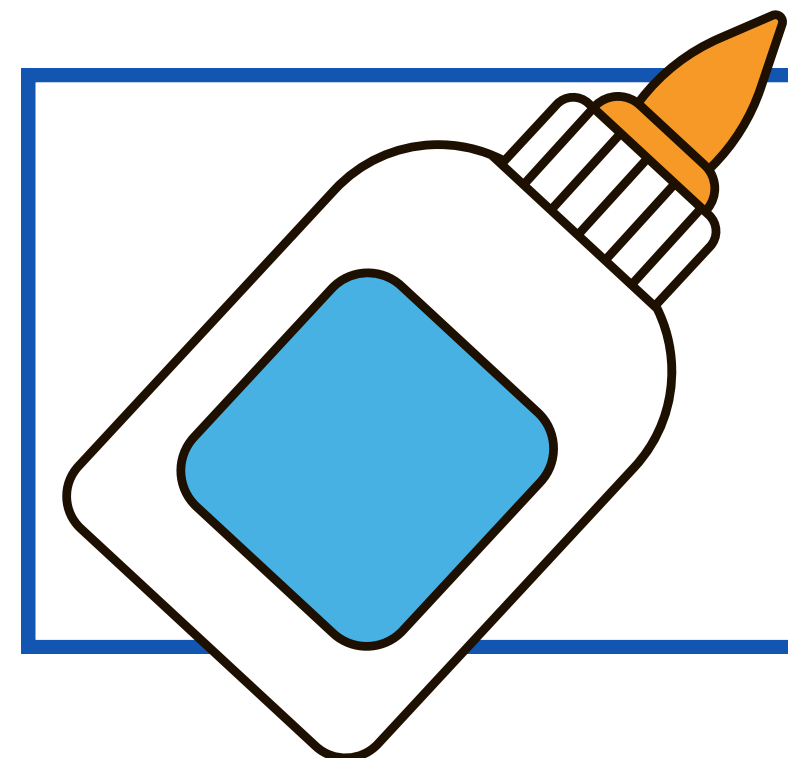

**PENCIL**

**SCHOOL BAG**

**BOOK**



**APOSTILA**  
**CONVERSAÇÃO I**

**Conteúdo - Elaboração - Diagramação:**  
**PROF<sup>a</sup>. RITA DE CÁSSIA BARBOSA DE MELO**  
**PROF. THIAGO VICENTE**

**Organização:**  
**SECRETARIA MUNICIPAL DE EDUCAÇÃO DE JACAREÍ**  
**Secretária de Educação**  
**ANA MONTEIRO**